

John

SITS



John

UPHOLSTERY

COMFORTS

COVERS

SPECIAL



fabric



STD standard



FC fixed



modular system

All elements available also as freestanding elements.

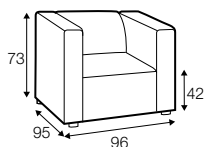

armchair

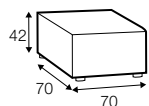

footstool 70x70

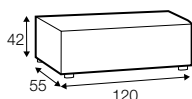

footstool 120x55

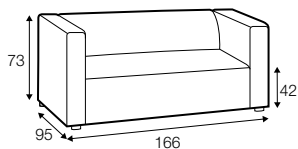

2 seater

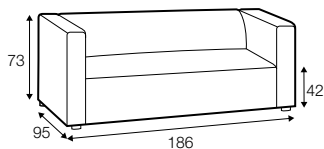

2,5 seater

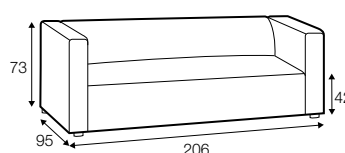

3 seater

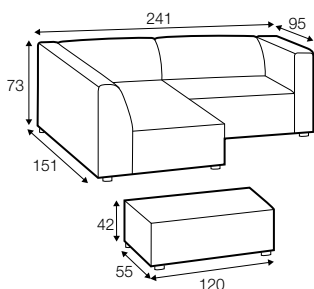

set 1 left / or right

element 120x151 left / or right
+ element 121x95 right / or left
+ footstool 120x55

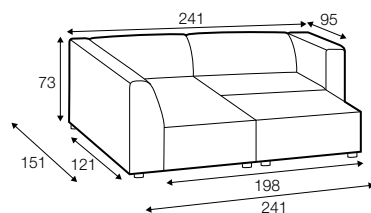

set 2

element 120x151 left
+ 2,5 seater without armrest
+ element 120x151 right

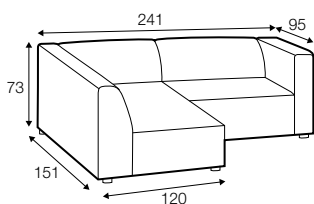

set 3 left / or right

element 120x151 left / or right
+ element 121x95 right / or left

modular system

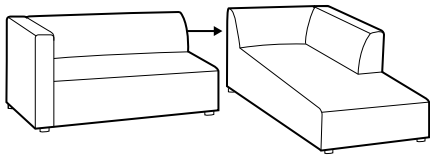

elements of the modular system

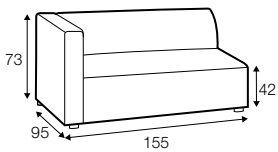

2 seater left / or right

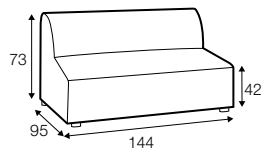

2 seater without armrests

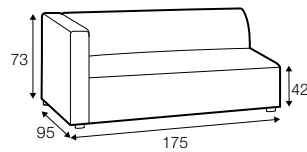

2,5 seater left / or right

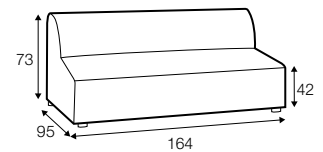

2,5 seater without armrests

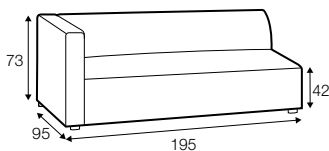

3 seater left / or right

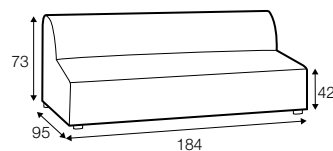

3 seater without armrests

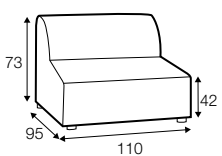

element 110x95
without armrests

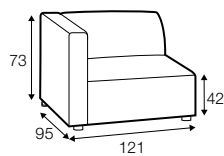

element 121x95
left / or right

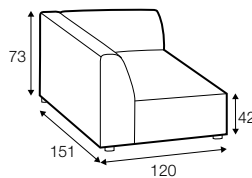

element 120x151
left / or right

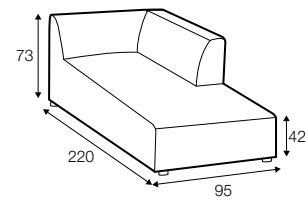

divan right / or left

extra dimensions

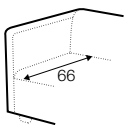

depth of seat

legs

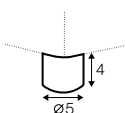

no. 37C
plastic

profile

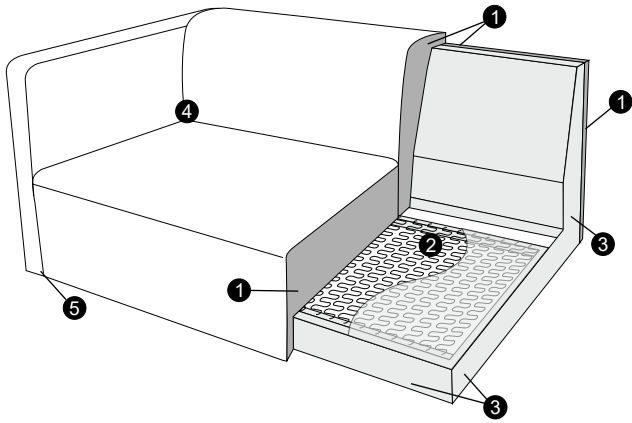

standard

1. polyurethane foam/ high resilient polyurethane foam
2. springs
3. FSC® certified solid wood and wood based elements
4. fabric
5. plastic legs