

# Maja

SITS



# Maja

UPHOLSTERY

COMFORTS

COVERS



fabric



STD standard

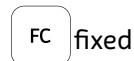

FC fixed

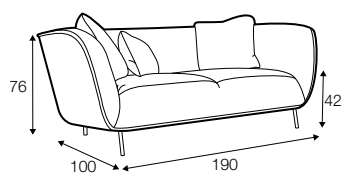

2 seater

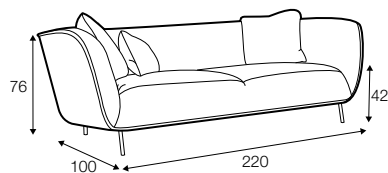

3 seater

## extra dimensions

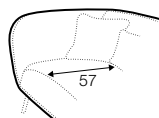

depth of seat

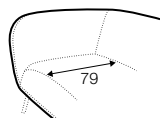

depth of seat  
without cushions

## legs

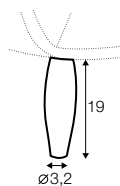

no. 164  
wood  
front

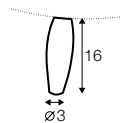

no. 164A  
wood  
back

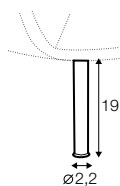

no. 165  
metal chrome,  
painted black or grey  
and brushed steel\*  
front

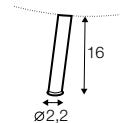

no. 165A  
metal chrome,  
painted black or grey  
and brushed steel\*  
back

\*please check a cost of brushed steel finish with a sale representative.

## profile

---

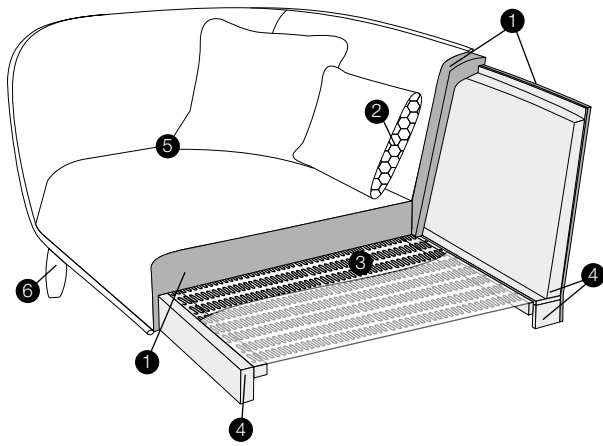

### standard

1. polyurethane foam/high resilient polyurethane foam
2. silicone balls
3. springs
4. FSC® certified solid wood and wood based elements
5. fabric
6. FSC® certified solid wood or metal legs